

Wireless-N Router Setup Manual



NETGEAR®

NETGEAR, Inc.
4500 Great America Parkway
Santa Clara, CA 95054 USA

May 2008
208-10259-01
v1.0

©2008 by NETGEAR, Inc. All rights reserved.

Trademarks

NETGEAR and the NETGEAR logo are trademarks of NETGEAR, Inc. Microsoft, Windows, and Windows NT are registered trademarks of Microsoft Corporation. Wi-Fi Protected Setup is a trademark of the Wi-Fi Alliance. Other brand and product names are registered trademarks or trademarks of their respective holders.

Statement of Conditions

In the interest of improving internal design, operational function, and/or reliability, NETGEAR reserves the right to make changes to the products described in this document without notice.

NETGEAR does not assume any liability that may occur due to the use or application of the product(s) or circuit layout(s) described herein.

Contents

Wireless-N Router Setup Manual

Getting to Know Your Wireless Router	1
Unpacking Your New Router	1
Hardware Features	3
Front Panel	3
Back Panel	5
Router Label	6
Positioning Your Wireless Router	6
Updating Your Router Firmware	7
Setting Up Your Wireless Security	7
Installing Your Wireless Router	7
Installing Your Router Using the Smart Wizard	9
Using the Smart Wizard	9
Accessing Your Router After Installation	10
Manually Installing Your Router	11
Connecting Your Wireless Router	12
Verifying Your Connection	15
Setting Up Your Router for Internet Access	16
Configuring Your Wireless Network	21
Specifying Wireless Settings	21
Setting Your SSID and Wireless Security Manually	21
Using Push 'N' Connect (WPS) to Configure Your Wireless Network	23
Testing Basic Wireless Connectivity	26
Troubleshooting	29
Basic Setup Checklist	29
Checking Basic Router Functions	30
Troubleshooting Login Problems	32

Checking the Internet Service Connection	33
Obtaining an Internet IP Address	33
Troubleshooting PPPoE	34
Troubleshooting Internet Browsing	35
Using the Ping Utility to Troubleshoot	35
Testing the Path from Your Computer to Your Router	35
Testing the Path from a Computer to the Internet	36
Technical Specifications	37
Default Configuration Settings	37
Restoring the Default Password and Configuration Settings	39
Related Documents	41
Registration and Certifications	43

Getting to Know Your Wireless Router

Congratulations on your purchase of a NETGEAR® high-speed wireless router, the Wireless-N Router Model WNR2000.

Before you begin installing your router, check the package contents (see “[Unpacking Your New Router](#)” on page 1). Become familiar with the front and back panels of your router—especially the status lights—and the important information on the router label (see “[Hardware Features](#)” on page 3). Then, read the section on “[Positioning Your Wireless Router](#)” on page 6 to ensure that you have selected the best location to install your router.

Unpacking Your New Router

Your product package should contain the following items:

- The Wireless-N Router
- A snap-on stand for your wireless router
- An AC power adapter (varies by region)
- A yellow Ethernet cable
- The *Resource CD*, which includes:
 - The Smart Wizard Installation Assistant (*Autorun.exe*)
 - A PDF version of this manual
 - A link to the online *User Manual*



A link to the online *User Manual* is also available from the router interface, after the router is installed. Click **Documentation** on the main menu.

- (A link to the online *User Manual* is also available from the router interface, after the router is installed).
- Warranty and Support Information cards

If any of the parts are incorrect, missing, or damaged, contact your NETGEAR dealer. Keep the carton, including the original packing materials, in case you need to return the product for repair.

To prepare your router for installation:

1. Carefully peel off the protective film covering both sides of your router (see [Figure 1](#)).

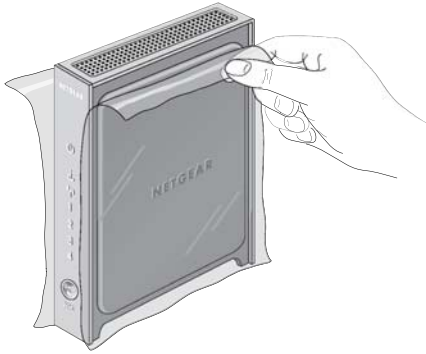

Figure 1

2. Set up your wireless router by inserting the tabs of the stand (supplied with your router) into the slots on the bottom of your router as shown in [Figure 2](#). Then, remove the protective film covering the status light panel of the router.



Figure 2

3. Place your router in a suitable area for installation (near an AC power outlet and accessible to the Ethernet cables for your wired computers).



To ensure proper heat dissipation and for router stability, it is important that you connect the stand and place your router in an upright position.

Hardware Features

Before you install and connect your router, take a moment to become familiar with the front and back panels of the router—especially the status lights on the front panel.

Front Panel

The router front panel, shown in [Figure 3](#), contains status lights. (For more information on interpreting the status lights, see [“Verifying Your Connection”](#) on page 15 and [“Checking Basic Router Functions”](#) on page 30.)

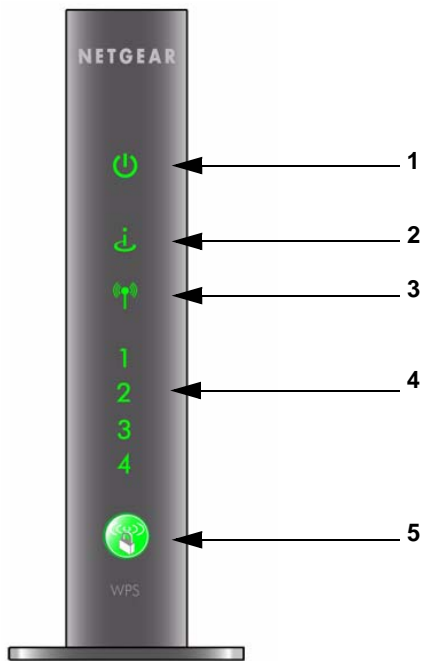

Figure 3

You can use the status lights to verify various conditions. [Table 1](#) describes each light.

Table 1. Status Light Descriptions

Label	LED Activity	Description
1. Power	Solid Amber Solid Green Fast blink–Green Slow blink–Green Off	The router is performing the power-on self-test diagnostic. The power is on and the router is ready. A software update is in progress. There is a problem with the wireless router software. Power is not being supplied to the router
2. Internet	Solid Amber Solid Green Blinking Green Off	No IP address acquired. The wireless router has acquired an Internet address. Data is being communicated with the Internet. No Ethernet cable is connected to the modem.
3. Wireless	Solid Blue Blinking Blue Off	The wireless interface is enabled. Data is being communicated over the wireless network. The wireless interface is turned off.
4. LAN (Ports 1–4)	Solid Green Blinking Green Solid Amber Blinking Amber Off	The local port is connected to a 100 Mbps device. Data is being transmitted at 100 Mbps. The local port is connected to a 10 Mbps device. Data is being transmitted at 10 Mbps. No link is detected on this port.
5. Push 'N' Connect	Solid Green Blinking Green Off	Indicates a (WPS) connection to a WPS-capable device. WPA-capable device can associate with the router within 2 minutes. No WPS connection exists.

Back Panel

The router back panel, shown in [Figure 4](#), contains port connections.

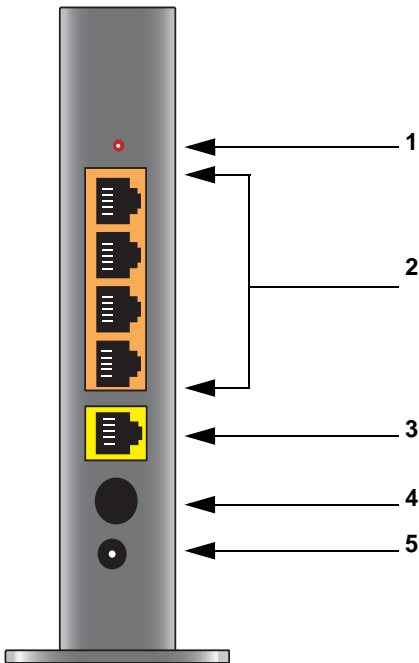

Figure 4

Viewed from top to bottom, the rear panel contains the following elements:

1. Restore factory settings button. Press for approximately 5 seconds to reset the router to the factory default settings.
2. Four Local Area Network (LAN) 10/100 Mbps Ethernet ports for connecting the router to your local computers.
3. Internet/Wide Area Network (WAN) Ethernet port for connecting the router to a cable or DSL modem.
4. Power on/off push-button.
5. AC power adapter outlet for connecting the power adapter.

Router Label

The label on the back of the wireless router shows the router's MAC address, serial number, security PIN, and factory default login information.

The ports on the router are color-coded to distinguish your Internet port from the other four ports that connect to the wired computer(s) on your Local Area Network (LAN).

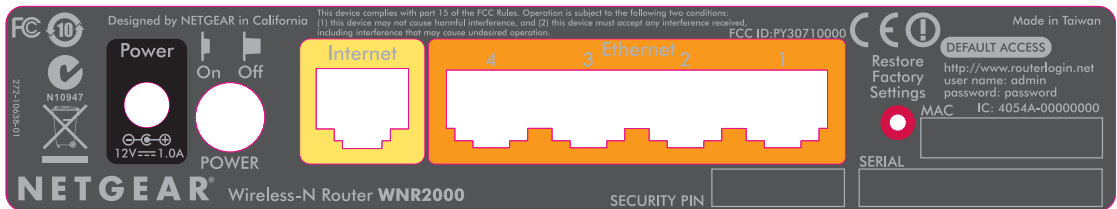

Figure 5

Positioning Your Wireless Router

The wireless router lets you access your network from virtually anywhere within the operating range of your wireless network. However, the operating distance or range of your wireless connection can vary significantly depending on the physical placement of your router. For example, the thickness and number of walls the wireless signal must pass through might limit the range. For best results, place your router:

- Near the center of the area where your computers and other devices will operate, preferably within line of sight to your wireless devices.
- Accessible to an AC power outlet and near Ethernet cables for wired computers.
- In an elevated location such as a high shelf, keeping the number of walls and ceilings between the wireless router and your other devices to a minimum.
- Away from electrical devices which are potential sources of interference, such as ceiling fans, home security systems, microwaves, or the base for a cordless phone.
- Away from any large metal surfaces, such as a solid metal door or aluminum studs. Large expanses of other materials such as glass, insulated walls, fish tanks, mirrors, brick, and concrete can also affect your wireless signal.



Failure to follow these guidelines can result in significant performance degradation or an inability to wirelessly connect to the Internet.

Updating Your Router Firmware

NETGEAR is always improving the operability and features included with your router. To make it easy for you to receive the best, most up-to-date features of your router, NETGEAR provides a variety of methods for updating your product.

- The Smart Wizard Installation Assistant lets you check for and install updates as part of the setup activity (see [“Using the Smart Wizard” on page 9](#)).
- The router includes an update feature that lets you check for and install updates. You must log in to the router to use this feature see [“Setting Up Your Router for Internet Access” on page 16](#), or the online *User Manual*).

Setting Up Your Wireless Security

To make it easy for you to select the security that best fits your network, NETGEAR provides several methods for configuring security:

- The Smart Wizard offers to guide you in setting up security at initial setup (see [“Using the Smart Wizard” on page 9](#)).
- If you have any devices (a notebook, adapter, or other device) that support Wi-Fi Protected Setup (WPS), you can enable WPS security (see [“Using Push 'N' Connect \(WPS\) to Configure Your Wireless Network” on page 23](#)).
- The router’s Wireless Settings screen lets you set your Wireless Network connections and select the appropriate and optimum security options for your network and router (see [“Setting Your SSID and Wireless Security Manually” on page 21](#)).

Installing Your Wireless Router

To help you set up your router and get on the Internet quickly, the *Resource CD* contains a Smart Wizard™ Installation Assistant. The Installation Assistant walks you through the steps required to

connect your router, modem, and PC(s); configure your wireless settings; and enable wireless security for your network. When you have finished, you will be Internet ready!



NETGEAR does not recommend or support adding a NETGEAR router behind another router, or replacing a gateway with a a NETGEAR router.

If you have a Macintosh or Linux system, you need to use the manual installation method (see [“Manually Installing Your Router” on page 11](#)).

You can set up your wireless router using one of two methods:

- **Smart Wizard Setup:** The Smart Wizard Installation Assistant setup is available on your *Resource CD*. See [“Installing Your Router Using the Smart Wizard” on page 9](#) to use the Smart Wizard Installation Assistant.
 - This is the easiest option. The wizard guides you through the setup process. It automates many of the steps and verifies that the steps have been successfully completed.
 - Smart Wizard requires a PC running Microsoft Windows.



Before running the Smart Wizard Installation Assistant on a corporate PC to set up your home router, check with your company’s network support staff. Corporate network settings or Virtual Private Network (VPN) client software might conflict with the default settings of a home router. If you are unsure about whether there might be a conflict, use a different computer.

- **Manual Setup:** If you cannot or prefer not to use the Smart Wizard Installation Assistant, see [“Manually Installing Your Router” on page 11](#). For example, if you are connecting to a Mac, are using a Linux operating system, or are technically knowledgeable, select this option. If you choose to use this option and install your router manually, for best results, install and set up your router in this order:
 1. Install and connect your wireless router to your network (see [“Connecting Your Wireless Router” on page 12](#)).
 2. Set up your wireless router for Internet access (see [“Setting Up Your Router for Internet Access” on page 16](#)).
 3. Configure your wireless network and select wireless security settings to protect your wireless network (see [“Configuring Your Wireless Network” on page 21](#)).

Installing Your Router Using the Smart Wizard

The Smart Wizard setup procedure should take about 15 minutes to complete. Before using the Smart Wizard to set up your router, ensure that:

- You are using a PC with Windows Vista, Windows 2000, or Windows XP with Service Pack 2, and with a wired Ethernet connection, not a wireless connection.
- You have an Internet service connection through an Internet Service Provider (ISP).
- You have the configuration information provided by your ISP.

Using the Smart Wizard

The NETGEAR Smart Wizard takes you through the procedure to connect your router, modem, and PC(s). It then helps you to configure your wireless settings and enable wireless security for your network. The Smart Wizard guides you through the setup process by automating many of the steps. At each step in the setup process, the Smart Wizard checks to ensure that the steps you perform are successfully completed.

To install your router using the Smart Wizard:

1. Insert the *Resource CD* into your Windows PC. The CD will automatically start and detect the language you are using on your PC. Select a different language option, if you prefer.



If the CD does not automatically start, browse the CD and double-click on  .

2. In the CD's menu, click **Setup** to start the Smart Wizard.
3. When the Smart Wizard prompts you about updates, click **Yes** to check for updates for your router, or **No**, to update later (for more information, see [“Setting Up Your Router for Internet Access” on page 16](#), or the online *User Manual*).
4. Follow the remaining instructions and prompts.

The Smart Wizard guides you through installing your router, connecting your router to the Internet, configuring your wireless network settings, and selecting the optimum security protection for your network. If you choose not to select a security option during installation, you can always access the router's user interface later to select a security option (see [“Configuring Your Wireless Network” on page 21](#)).



To ensure optimum performance of your high-speed wireless router, the wireless adapter card for each computer in your network should support the same technology as your router. For more information, see the online *User Manual*.

You are now connected to the Internet.

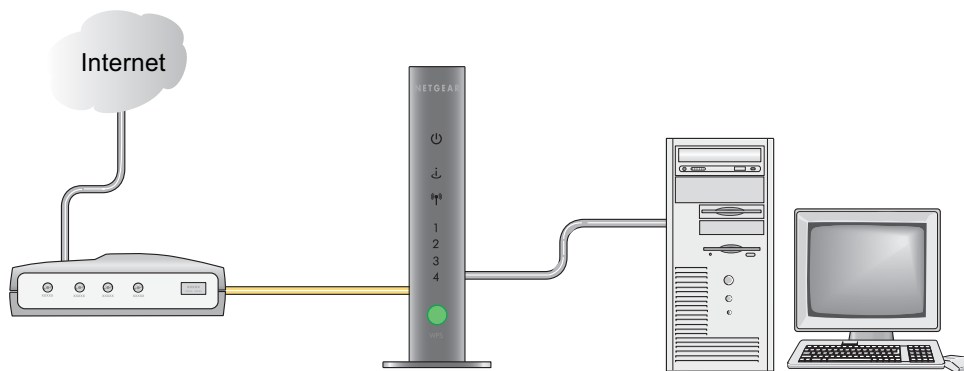

Figure 6

To set up additional wireless computers in your network to access the router and connect to the Internet, see [“Configuring Your Wireless Network” on page 21](#).

Accessing Your Router After Installation

The Smart Wizard only appears when you first install the router or when the router is in its factory default state (for example, if you have reset the router to its default factory settings). If you want to change the settings after installing and configuring your router using the Smart Wizard, you must open a browser window and log in to the router. You will also be prompted to check for new router firmware. For more information, see [“Configuring Your Wireless Network” on page 21](#).

Manually Installing Your Router

Before installing and connecting your router manually, review the list below and make sure that you have all of the necessary information.



Use the procedures in this topic if you are an advanced user, or a user of Macintosh and Linux systems.

- Internet service connection through an Internet Service Provider (ISP).
- The configuration information your ISP gave you. Depending on how your Internet account was set up, you might need the following information to set up your wireless router and access the Internet:
 - Host and domain name
 - Internet login name and password (frequently an email address and password)
 - Domain Name Server (DNS) addresses
 - Fixed or static IP address

Your ISP should have provided you with all the information needed to connect to the Internet. If you cannot locate this information, ask your ISP.

- If you have cable modem service, make sure that you are using the same computer on which you first set up your Internet account.

If you have not already done so:

- Check the package contents of your router to ensure that it is complete (see [“Unpacking Your New Router” on page 1](#)”).
- Select an optimum location for your wireless router after reviewing the guidelines presented in [“Positioning Your Wireless Router” on page 6](#).”

Connecting Your Wireless Router

Before you install your wireless router, make sure that the Internet Protocol (TCP/IP) Property settings on your computer are set to “automatically obtain an IP address” using DHCP and “Obtain DNS server address automatically.” You can check these settings by looking at the TCP/IP Properties of your Internal Network Connections, which are accessible through the Control Panel of your computer. If you are unsure about this, refer to the documentation for your computer or see the link to TCP/IP Addressing in [“Related Documents” on page 41](#).

If you are replacing an existing router, disconnect it completely from your network and set it aside before starting to install your new router. Then, skip to [step 5](#) in the following procedure



NETGEAR does not recommend or support adding a NETGEAR router behind another router, or replacing a gateway with a NETGEAR router.

To connect the wireless router, the computer, and the modem:

1. Turn off your computer.
2. Turn off and unplug the cable or DSL broadband modem.
3. Locate the cable (A) that connects your computer to the modem.
4. Disconnect the cable at the modem end only (B). You will connect it to the router later.

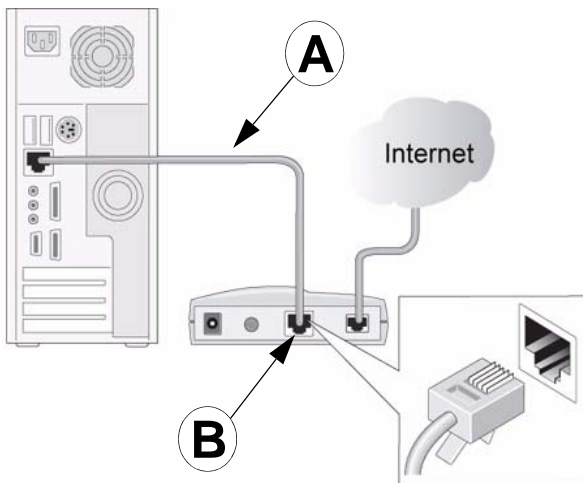

Figure 7

5. Locate the Ethernet cable that came with your NETGEAR product. Securely insert one end of the Ethernet cable into your modem (C) and the other end into the Internet port of the wireless router (D). (The cable and the Internet port label are color coded.)

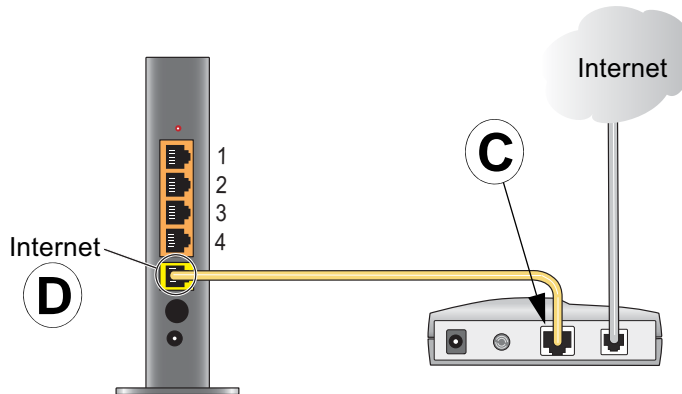

Figure 8

6. Locate the cable (A) that is still attached to your computer (see [step 4](#)). Securely insert that cable into a port on the router, such as port 4 (E), as shown in [Figure 9](#).

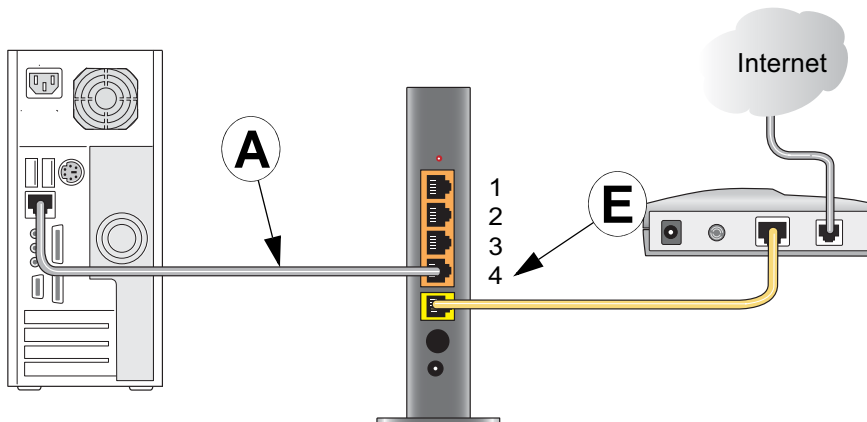

Figure 9

7. Connect any additional wired PCs to your router by inserting an Ethernet cable from a PC into one of the three remaining LAN ports.

- Review that your network is now set up (as shown in [Figure 10](#)); you are ready to start your network.

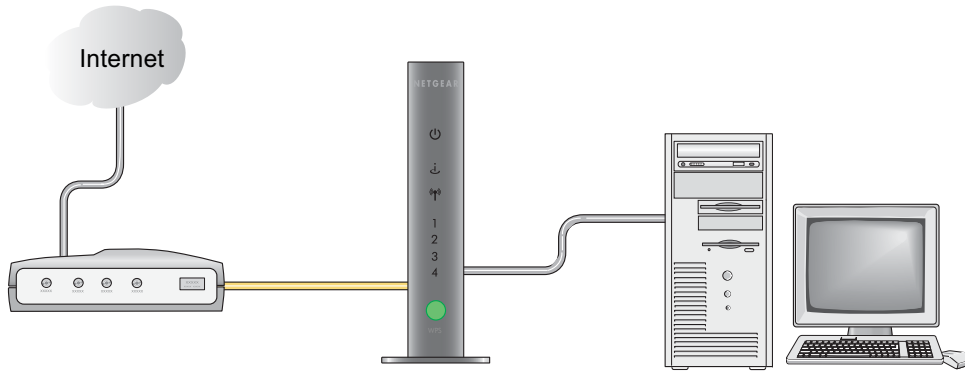

Figure 10

- Start your network in the correct sequence, as described below.



Failure to start or restart your network in the correct sequence could prevent you from accessing the Internet.

To start your network:

- Plug in and turn on the cable or DSL modem. Wait 2 minutes.
- Plug the end of the power adapter's cord into the wall or a power strip, and into the power adapter outlet of your wireless router (**F**). Wait 1 minute.

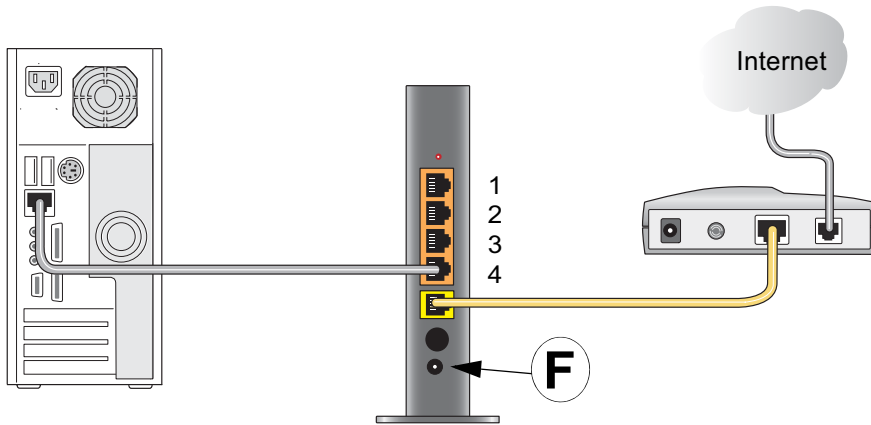

Figure 11

3. Turn on your computer. It will take several minutes for your router to establish a connection with your computer and your Internet provider.



For DSL customers, if software logs you in to the Internet, *do not* run that software. You might need to go to the Internet Explorer Tools menu, Internet Options, Connections tab and select “Never dial a connection.”

Verifying Your Connection

Verify that your router is connected correctly by checking the wireless router status lights (as illustrated in [Figure 12](#)).

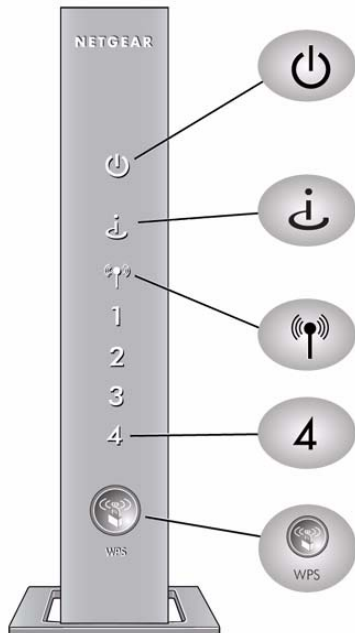

Figure 12

Power. The power light should turn solid green. If it does not, see [“Checking Basic Router Functions”](#) on page 30.

Internet. The Internet port light should be lit. If it is not, make sure the Ethernet cable is securely attached to the wireless router Internet port and the modem, and that the modem is powered on.

Wireless. The wireless light should be lit after turning on the router.

LAN. A LAN light (1-4) should be lit for each connected computer on your network. Green indicates that your computer is communicating at 100 Mbps; amber indicates communication at 10 Mbps. If a LAN light is not lit for each connected Ethernet cable, make sure that the Ethernet cable from the computer to the router is securely attached at both ends, and that the computer is turned on.

WPS. The WPS button/light will not be lit unless you push it to enable Push ‘N’ Connect (WPS) security. See [“Using Push ‘N’ Connect \(WPS\) to Configure Your Wireless Network”](#) on page 23.

Setting Up Your Router for Internet Access

When configuring your wireless router manually, you must log in to your wireless router to set it up initially and to make any changes to your wireless router’s settings later.



The factory default state is reset when you use the Restore Factory Settings button. See [“Restoring the Default Password and Configuration Settings”](#) on page 39 for more information.

To access the router:

1. Type **http://www.routerlogin.net** in the address field of your browser, and then click **Enter**.



You can enter either of these addresses to connect to your wireless router:
http://www.routerlogin.net or **http://www.routerlogin.com**.

A login window similar to the one shown in [Figure 13](#) will display.



Figure 13

2. When prompted, enter **admin** for the router user name and **password** for the router password, both in lowercase letters. (For security reasons, the router has its own user name and password.)



The router user name and password are not the same as any user name or password you might use to log in to your Internet connection.

The **Firmware Upgrade Assistant** screen will display.

3. Click **Yes** to check for new firmware (recommended). The router will automatically check the NETGEAR database for a new firmware image file. If no new firmware version is available, the message “No New Firmware Version Available” will display. (If you select “No,” you can check for new firmware later; see the online *User Manual*.)
4. If new firmware is available, click **Yes**, and the router will automatically upgrade itself with the latest firmware.



Do not try to go online, turn off the router, shut down the computer, or do anything else to the router until the router finishes restarting! When the Ready light stops blinking, wait a few seconds more before using the router.

- From the menu options in the left navigation pane, click **Setup Wizard**. The Setup Wizard screen will display.

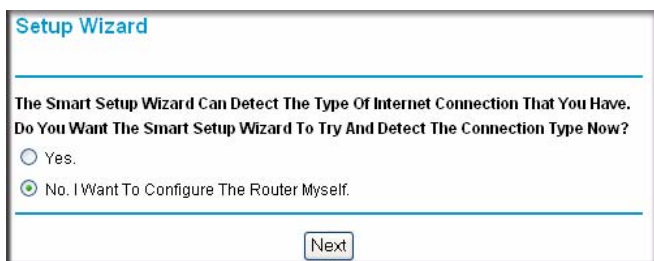

Figure 14

- Select one of the following options:
 - Select **Yes** to allow the Setup Wizard to detect your Internet connection. When prompted, click **Next**. The wizard will assist you with configuring your wireless router to access the Internet.



If you cannot connect to the wireless router, check the Internet Protocol (TCP/IP) properties in the Network Connections section of your Control Panel. It should be set to obtain *both* IP and DNS server addresses automatically. For assistance, see your computer documentation or see the links in “[Related Documents](#)” on page 41.

- Select **No** to set up the connection yourself. Click **Next** and the **Basic Settings** screen will display. Enter the required information for your ISP connection in the appropriate fields. If you need assistance, follow the **Basic Settings Help** screens on the router interface or see the online *User Manual* for this wireless router.



For more information about configuring settings, see “[Configuring Your Wireless Network](#)” on page 21.

- Click **Apply** to save your settings and complete your connection.

You should now be connected to the Internet!

If you do not connect successfully:

- Review your settings and make sure that you have selected the correct options and typed everything correctly.
- Contact your ISP to verify that you have the correct configuration information.
- Read [“Troubleshooting” on page 29](#).

If problems persist, register your NETGEAR product and contact NETGEAR Technical Support.

Configuring Your Wireless Network

This section describes additional configuration and testing for your network, after you have performed basic installation of the Wireless-N Router.

For a wireless connection, the router and each wireless computer must use the same SSID, also called the wireless network name, and the same wireless security. NETGEAR strongly recommends that you use wireless security.



Indoors, computers can connect over wireless networks at a range of several hundred feet. This can allow others outside of your immediate area to access your network.

Specifying Wireless Settings

The Wireless Settings screen lets you set your wireless network connections and the wireless security option for your network and router. To configure the wireless network, you can either manually specify your network name (SSID) and your wireless security settings (see [“Setting Your SSID and Wireless Security Manually” on page 21](#)) or, if the clients in your network are WPS capable, you can use Wi-Fi Protected Setup (WPS) to automatically set the SSID and implement WPA/WPA2 security on both the router and the client device (see [“Using Push 'N' Connect \(WPS\) to Configure Your Wireless Network” on page 23](#)).



If you configure the router from a wireless computer and you change the router's SSID, channel, or security settings, you will lose your wireless connection when you click **Apply**. You must then change your computer's wireless settings to match the router's new settings. To avoid this situation, you can use a computer that is connected to the router with an Ethernet cable.

For a complete overview of all the security configurations that can be implemented on this router, see the online *User Manual*.

Setting Your SSID and Wireless Security Manually

To specify the wireless settings, you must know the following:

- SSID. The default SSID for the router is NETGEAR.

- The wireless mode (802.11g/b, or 802.11n) that each wireless adapter supports.
- Wireless security option. NETGEAR strongly recommends that you use wireless security. To successfully implement wireless security, check each wireless adapter to determine which wireless security option it supports.

To set up basic wireless connectivity:

1. Log in to the wireless router as described in “To access the router:” on page 16.
2. On the main menu, select **Wireless Settings** to display the Wireless Settings screen.

Note that the default SSID is **NETGEAR**.



The SSID of any wireless adapters must match the SSID you configure in the wireless router. If they do not match, you will not get a wireless connection.

3. Set the **Region**. Select the region where the router is located.
4. Leave the wireless mode at its default setting.
5. Click **Apply** to save your changes.

To set up your computers for wireless connectivity:

1. Program the wireless settings of each computer or wireless adapter to have the same SSID (wireless network name) as the router.
2. Check that the wireless adapter on each computer can support the mode and security option that you selected. (If you have a question, see the online *User Manual* or review the settings you selected previously).
3. Check that the security settings on each wireless device match the security settings of the router. For example, if you selected a security option requiring a passphrase, then the same passphrase must be used for each wireless computer.
4. Check that each wireless computer has a wireless link and is able to obtain an IP address by DHCP from the router.



For a Windows PC, go to the Control Panel and select Network Connections. Check the Wireless Connections Properties and ensure that TCP/IP Properties are set to Obtain an IP address automatically.

To access the Internet from any computer connected to your wireless router, launch a browser such as Microsoft Internet Explorer or Netscape Navigator. You should see the wireless router's Internet LED blink, indicating communication to the ISP.

Using Push 'N' Connect (WPS) to Configure Your Wireless Network

If your wireless clients support Wi-Fi Protected Setup (WPS), you can use this feature to configure the router's SSID and security settings and, at the same time, connect the wireless client securely and easily to the router (computers that will connect wirelessly to the router are clients). Look for the  symbol on your client device.¹ WPS automatically configures the SSID and wireless security settings for the router (if the router is in its default state) and broadcasts these settings to the wireless client.



NETGEAR's Push 'N' Connect feature is based on the Wi-Fi Protected Setup (WPS) standard. All other Wi-Fi-certified and WPS-capable products should be compatible with NETGEAR products that implement Push 'N' Connect.

If the router has already been configured manually, and either WPS-PSK or WPA2-PSK security has been enabled, a wireless client can be connected quickly and simply by using the WPS method of connecting to the wireless network. In this case, the router preserves its existing wireless settings and broadcasts them to the WPS-capable client.



If you choose to use WPS, the only security methods supported are WPA-PSK and WPA2-PSK. WEP security is not supported by WPS.

If you install a NETGEAR adapter that supports WPS, its installation procedures guide you through a WPS connection without the need to log in to the router. However, if you wish to perform any WPS connection using the router settings, use the procedures below. (For more information on setting up a mixed network, see the online *User Manual*.)

To add a WPS client to your network:

1. Log in to the wireless router, type **http://www.routerlogin.net** or **http://www.routerlogin.com** in the address field of your browser, and then click **Enter**.

1. For a list of other Wi-Fi-certified products available from NETGEAR, go to <http://www.wi-fi.org>.

2. On the router main menu, select **Add a WPS Client**. The Add WPS Client wizard screen displays. Click **Next**.

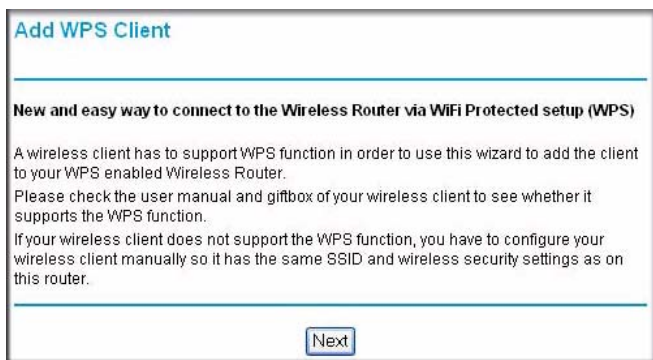

Figure 15

3. Select the method for adding the WPS client. A WPS client can be added using the push-button method or the PIN method.
 - **Using the Push-Button.** This is the preferred method.
 - Select the **Push-Button** radio box and either press the WPS push-button on the router or click the soft WPS push-button on the screen (as shown below).
 - The router will attempt to communicate with the client; you have 2 minutes to enable WPS from the client device using the client’s WPS networking utility.

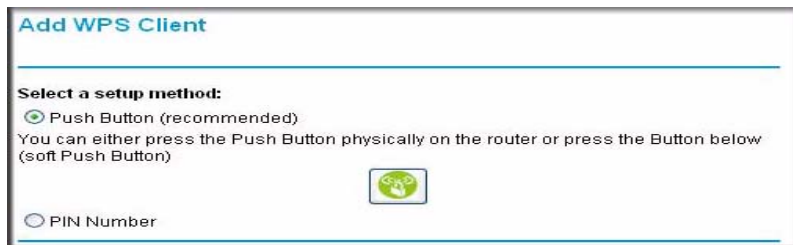

Figure 16

- **Entering a PIN.** If you want to use the PIN method, select the **PIN** radio box. A screen similar to the one shown below displays.
 - Go to your wireless client and, from the client’s WPS utility, obtain the wireless client’s security PIN, or follow the client’s WPS utility instructions to generate a security PIN.

- Then, enter this PIN in the **Enter Client's PIN** field provided on the router and click **Next**. You have 4 minutes to enable WPS on the router using this method.

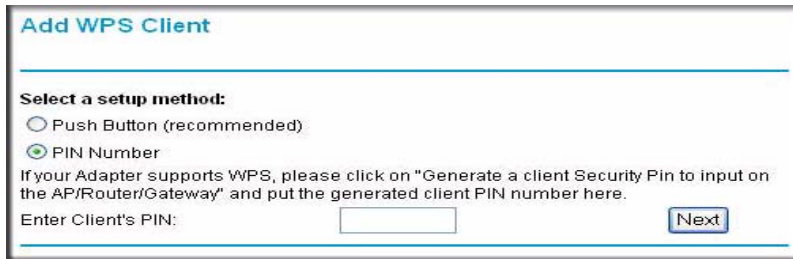

Figure 17

Using either method, the client wireless device will attempt to detect the WPS signal from the router and establish a wireless connection in the time allotted.

- If no connection is detected:
 - WPS did not establish a secure connection with a wireless device.
 - Neither the SSID nor the WPA/WPA2 security settings were configured on the router.
- If a connection is established:
 - The router WPS screen displays a message confirming that the wireless client was successfully added to your wireless network.
 - The router generated an SSID, implemented WPA/WPA2 wireless security (including a PSK security password), and broadcast these settings to the client; the client now shares the same security settings as the router.



If the router was already configured manually, and either WPS/PSK or WPA2/PSK security enabled and a PSK security password selected, then the client now shares these same security settings.

4. Note your SSID and WPA/WPA2 PSK security password (whether previously set or generated) for your wireless network.

To access the Internet from any computer connected to your wireless router, launch a browser such as Microsoft Internet Explorer or Netscape Navigator. You should see the wireless router's Internet LED blink, indicating communication to the ISP.



If you are planning a mixed network of WPS capable devices and non-WPS capable devices, NETGEAR suggests that you set up your wireless network and security settings manually first, and only use WPS for adding the WPS capable devices.

For more information on setting up your wireless network and configuring your wireless security settings, see the online *User Manual*.

Testing Basic Wireless Connectivity

Once you have established basic wireless connectivity, you can enable security settings appropriate to your needs.

To set up and test basic wireless connectivity:

1. Log in to the wireless router as described in “[To access the router:](#)” on page 16.
2. Click **Wireless Settings** in the main menu.
3. Note whatever SSID you have set up.



The SSID of any wireless adapters must match the SSID you configure in the wireless router. If they do not match, you will not get a wireless connection. If you are configuring the router from a wireless computer and you change the router's SSID, channel, or security settings, you will lose your wireless connection when you click **Apply**. You must then change the wireless settings of your computer to match the router's new settings.

4. Configure and test your computers for wireless connectivity.

Program the wireless adapter of your computers to have the same wireless network name (SSID) as the wireless router. Check that they have a wireless link and are able to obtain an IP address by DHCP from the router.

Your wireless router is now configured to provide Internet access for your network. Your wireless router automatically connects to the Internet when one of your computers requires access. It is not necessary to run a dialer or login application such as Dial-Up Networking or Enternet to connect,

log in, or disconnect. These functions are performed automatically by the wireless router as needed.

To access the Internet from any computer connected to your wireless router, launch a browser such as Microsoft Internet Explorer or Netscape Navigator. You should see the wireless router's Internet LED blink, indicating communication to the ISP. The browser should begin to display a Web page.

Troubleshooting

If you have difficulties accessing the Internet, use the Basic Setup Checklist to make sure that you have connected and set up your router correctly. If your basic setup is correct, then look for your problem in one of the subsequent sections.



For more information, refer to the online *User Manual*. A link to this document is included on the *Resource CD*, and is also available from the router interface, after the router is installed. Click **Documentation** on the main menu.

Basic Setup Checklist

The following items are the most common errors made when initially setting up a router. Carefully review the checklist to make sure that you have followed the recommended procedures.

- **Be sure you always start your network in this sequence:**
 1. Turn off and unplug the modem from the power outlet. Next, turn off the wireless router and computer.
 2. Turn on the modem and wait 2 minutes.
 3. Turn on the wireless router and wait 1 minute.
 4. Turn on the computer.
- **Make sure the Ethernet cables are securely plugged in.**
 - The Internet status light on the wireless router will be lit if the Ethernet cable to the wireless router from the modem is plugged in securely and the modem and wireless router are both turned on (see [“Connecting Your Wireless Router” on page 12](#)).
 - For each powered-on computer connected to the wireless router with a securely plugged-in Ethernet cable, the corresponding wireless router LAN port status light will be lit. The label on the back of the wireless router identifies the number of each LAN port (see [“Restore factory settings button. Press for approximately 5 seconds to reset the router to the factory default settings.” on page 5](#)).
- **Make sure the network settings of the computer are correct.**

- LAN connected computers *must* be configured to obtain an IP address automatically using DHCP. For more information, see the links in [“Related Documents” on page 41](#).
- Some cable modem services require you to use the MAC address of the computer registered on the account. If so, in the Router MAC Address section of the Basic Settings menu, select “Use this Computer’s MAC Address.” Click **Apply** to save your settings. Restart the network in the correct sequence.
- **Check the router status lights to verify correct router operation.** If the Power light does not turn solid green within 2 minutes after turning the router on, reset the router according to the instructions in [“Restoring the Default Password and Configuration Settings” on page 39](#).

Checking Basic Router Functions

After you turn on power to the router, check that the following sequence of events has occurred:

1. When power is first applied, verify that the power light is on (see [“Front Panel” on page 3](#) for an illustration).
2. Verify that the power light turns amber within a few seconds, indicating that the self-test procedure is running.
3. After approximately 20 seconds, verify that:
 - a. The color of the power light changes to green.
 - b. The LAN port lights are lit for any local ports that are connected.

If a port’s light is lit, a link has been established to the connected device. If a LAN port is connected to a 100 Mbps device, verify that the port’s light is green. If the port is 10 Mbps, the light will be amber.
 - c. The Internet port is connected and its light is lit.
4. If you have enabled WPS security, verify that the push-button stops blinking and changes to green (otherwise the push-button light should be off).

If the correct behavior does not occur, check for a remedy from the following list:

- **Power Light Not On.** If the Power and other lights are off (see [“Connecting Your Wireless Router” on page 12](#)), check the following:
 - Make sure that the power cord is properly connected to your router and that the power adapter is properly connected to a functioning power outlet.
 - Check that you are using the power adapter supplied by NETGEAR for this product.

If the error persists, you have a hardware problem and should contact technical support.

- **Power Light Blinks Green Slowly and Continuously.** The router firmware is corrupted.

To restore your firmware:

- a. Make sure your PC is connected to your router and the router is powered on.
 - b. Insert the *Resource CD* that came with your router into your PC.
 - The CD will automatically start and detect the language you are using on your PC. Select a different language option, if you prefer.
 - If the CD does not automatically start, browse the CD and double-click on .
 - c. Click **Supporting Software**, then **Netgear Firmware Recovery Utility**, and follow the prompts for the recovery process.
 - d. After firmware recovery is complete, follow the prompts to restore your configuration settings.
- **Power Light Stays Amber.** When the router is turned on, the Power light turns amber for about 20 seconds and then turns green. If the light does not turn green, the router has a problem.

If the Power light is still amber 1 minute after turning on power to the router:

- a. Turn the power off and back on to see if the router recovers.
- b. Clear the router's configuration to factory defaults. This will set the router's IP address to 192.168.1.1. This procedure is explained in [“Restoring the Default Password and Configuration Settings” on page 39.](#)

If the error persists, you might have a hardware problem and should contact technical support.

- **Internet Light Stays Amber.** When the router is turned on, the Internet light turns amber for about 20 seconds and then turns green. If the light does not turn green, the router has a problem.

If the Internet light is still amber 1 minute after turning on power to the router:

- a. The Internet is not accessible. Confirm that you have the correct internet setting.
- b. Clear the router's configuration to factory defaults. This will set the router's IP address to 192.168.1.1. This procedure is explained in [“Restoring the Default Password and Configuration Settings” on page 39.](#)
- c. Turn the power off and back on to see if the router recovers.

- **Internet or LAN Port Lights Not On.** If either the LAN or Internet lights do not light when the Ethernet connection is made, check the following:
 - a. Make sure that the Ethernet cable connections are secure at the router and at the computer.
 - b. Make sure that power is turned on to the connected computer.
 - c. Be sure you are using Ethernet cables like the cable that was supplied with the wireless router.

See [“Connecting Your Wireless Router” on page 12](#) for instructions.

For more information on WPS functionality and advanced features, see the online *User Manual*.

Troubleshooting Login Problems

If you are unable to log in to the wireless router, check the following:

- If you are using an Ethernet-connected computer, check the Ethernet connection between the computer and the router as described in [“Checking Basic Router Functions” on page 30](#).
- Make sure you are using the correct login information. The factory default login name is **admin** and the password is **password**. Make sure that the Caps Lock is off when entering this information.
- Make sure your computer’s IP address is on the same subnet as the router. If you are using the recommended addressing scheme, your computer’s address should be in the range of 192.168.1.2 to 192.168.1.254. Refer to your computer’s documentation or see [“Preparing a Computer for Network Access”](#) in [“Related Documents” on page 41](#) for help with configuring your computer.



If your computer cannot reach a DHCP server, some operating systems will assign an IP address in the range 169.254.x.x. If your IP address is in this range, verify that you have a good connection from the computer to the router, then restart (reboot) your computer.

- If your router’s IP address has been changed and you don’t know the current IP address, reset the router’s configuration to the factory defaults. This procedure will reset the router’s IP address to 192.168.1.1 (see [“Restoring the Default Password and Configuration Settings” on page 39](#)).
- Make sure your browser has Java, JavaScript, or ActiveX enabled. If you are using Internet Explorer, click Refresh to be sure the Java applet is loaded. Try closing the browser and reopening it again.

- If you are attempting to set up your NETGEAR router as an additional router behind an existing router in your network, consider replacing the existing router instead. NETGEAR does not support such a configuration.
- If you are attempting to set up your NETGEAR router as a replacement for an ADSL gateway in your network, the router cannot perform many gateway services, for example, converting ADSL or Cable data into Ethernet networking information. NETGEAR does not support such a configuration.

Checking the Internet Service Connection

If your router is unable to access the Internet, check the Internet connection, and then check the wireless router.

- **Internet Connection.** The cable or DSL modem status lights indicate if the modem connection is successful or not. Check your modem documentation or call your Internet service provider for help with verifying that the modem has a successful connection.
- **Wireless Router Internet Light is Green or Blinking Green.** If your Internet light is green or blinking green, then you have a good Internet connection and your wiring is correct.
- **Wireless Router Internet Light Off.** If the Internet light is off, verify that the Ethernet cable is securely connected between the cable or DSL modem, and that both the modem and wireless router are turned on.

Obtaining an Internet IP Address

If your wireless router is unable to access the Internet, and your Internet light is amber, check the wireless router to see if it is able to get an Internet IP address from your service provider. Unless you have a static IP address, your wireless router automatically requests an IP address from your service provider.

To check the Internet IP address from the browser interface:

1. Log in to the wireless router.
2. Select the **Router Status** link under the **Maintenance** heading to check that an IP address is shown for the Internet Port. If 0.0.0.0 is shown, your wireless router has not obtained an IP address from your service provider.

If your router is unable to obtain an IP address from the your service provider, the problem might be one of the following:

- Your service provider might require a login. Ask your service provider whether they require a PPP over Ethernet (PPPoE) login.
- You might have incorrectly set the service name, user name or password. See [“Troubleshooting PPPoE” on page 34](#).
- Your service provider might check for your computer's host name. Assign the computer Host Name of your ISP account to the wireless router on the **Basic Settings** screen.
- Your service provider might only allow one Ethernet MAC address to connect to the Internet, and check for your computer’s MAC address. If this is the case:
 - Inform your service provider that you have bought a new network device, and ask them to use the wireless router’s MAC address, or
 - Configure your router to spoof your computer’s MAC address. On the **Basic Settings** screen in the Router MAC Address section, select “Use this Computer’s MAC Address” and click **Apply**. Then restart your network in the correct sequence (see [“Basic Setup Checklist” on page 29](#)).

Troubleshooting PPPoE

If you are using PPPoE, try troubleshooting your Internet connection.

To troubleshoot a PPPoE connection:

1. Log in to the wireless router.
2. Select **Router Status** under **Maintenance** on the main menu.
3. Click **Connection Status**. If all of the steps indicate “OK,” then your PPPoE connection is up and working.

If any of the steps indicate “Failed,” you can attempt to reconnect by clicking **Connect**. The wireless router will continue to attempt to connect indefinitely.

If you cannot connect after several minutes, you might be using an incorrect service name, user name, or password. There also might be a provisioning problem with your ISP.



Unless you connect manually, the wireless router will not authenticate using PPPoE until data is transmitted to the network.

Troubleshooting Internet Browsing

If your wireless router can obtain an IP address but your computer is unable to load any web pages from the Internet, check the following:

- **Your computer might not recognize any DNS server addresses.** A DNS server is a host on the Internet that translates Internet names (such as `www` addresses) to numeric IP addresses. Typically, your ISP will provide the addresses of one or two DNS servers for your use. If you entered a DNS address during the wireless router's configuration, restart your computer. Alternatively, you can configure your computer manually with a DNS address, as explained in the documentation for your computer.
- **Your computer might not have the wireless router configured as its default gateway.** Reboot the computer and verify that the wireless router address (192.168.1.1) is listed by your computer as the default gateway address.

Using the Ping Utility to Troubleshoot

Most computers and routers have a diagnostic utility called *ping* that sends a request to a target device. The device then replies. The ping utility makes it easy to troubleshoot a network.

Testing the Path from Your Computer to Your Router

You can ping the wireless router to verify that the LAN path from your computer to your router is set up correctly.

To ping the wireless router from a Windows PC:

1. From the Windows task bar, click **Start** and select **Run**.
2. In the field provided, type `ping` followed by the address of the router, as in this example:

```
ping www.routerlogin.net
```

3. Click **OK**. You should see a message like this one:

```
Pinging www.routerlogin.net with 32 bytes of data
```

If the path is working, you see this message:

```
Reply from www.routerlogin.net: bytes=32 time=NN ms TTL=xxx
```

If the path is not working, you see this message:

```
Request timed out
```

If the path is not working correctly, you could have one of the following problems:

- Wrong physical connections
 - Make sure the LAN port light is on. If the light is off, follow the instructions in “[Basic Setup Checklist](#)” on page 29.
 - Check that the corresponding lights are on for your computer’s network interface card.
- Wrong network configuration
 - Verify that the Ethernet card driver software and TCP/IP software are both installed and configured on your computer.
 - Verify that the IP addresses for your router and your computer are correct and that both addresses are on the same subnet (for example, 192.168.1.x/255.255.255.0).

Testing the Path from a Computer to the Internet

After verifying that the path between your computer and the wireless router works correctly, test the path from your PC to the Internet.

To test the path using ping from a Windows PC:

1. From the Windows task bar, click **Start** and select **Run**.
2. In the field provided, type `cmd`. A command screen will display.
3. At the `>` prompt, type the following:

```
ping -n 10 <IP address>
```

where *<IP address>* is the IP address of a remote device such as your ISP’s DNS server.

4. Press **Enter**.

If the path is working correctly, replies as in the previous section will display. If you do not receive replies:

- Check that your PC has the IP address of your router listed as the default gateway. If the IP configuration of your PC is assigned by DHCP, this information will not be visible in your PC’s Network Control Panel. Verify that the IP address of the router is listed as the TCP/IP default gateway.
- Check to see that the network address of your PC (the portion of the IP address specified by the netmask) is different from the network address of the remote device.
- If your ISP assigned a host name to your PC, enter that host name as the Account Name in the Basic Settings menu.

Technical Specifications

Default Configuration Settings

This section provides factory default settings and technical specifications for the Wireless-N Router Model WNR2000.

Table 2. Home Router Default Configuration Settings

Feature	Default Setting
Router Login	
Router Login URL	http://www.routerlogin.net; http://www.routerlogin.com; or http://192.168.1.1
Login Name (case sensitive)	admin
Login Password (case sensitive)	password
Internet Connection	
WAN MAC Address	Default hardware address (on label)
MTU Size	1500
Local Network	
Router Lan IP address (the Gateway IP address)	192.168.1.1
IP Subnet Mask	255.255.255.0
DHCP Server	Enabled
Time Zone	GMT
Time Zone Adjusted for Daylight Saving Time	Disabled
Firewall	
Inbound (communications coming in from the Internet)	Disabled (bars all unsolicited requests except for traffic on port 80, the http port)
Outbound (communications going out to the Internet)	Enabled (all)

Table 2. Home Router Default Configuration Settings (continued)

Feature	Default Setting	
Wireless		
	Wireless Communication	Enabled
	SSID Name	NETGEAR
	Security	Disabled
	Broadcast SSID	Enabled
	Transmission Speed	Auto ^a
	Country/Region	United States (North America only; otherwise varies by country and region)
	RF Channel	11 in North America, 13 in most other regions
	Operating Mode	Up to 145 Mbps
	Data Rate	Best
	Output Power	Full

a. Maximum Wireless signal rate derived from IEEE Standard 802.11 specifications. Actual throughput will vary. Network conditions and environmental factors, including volume of network traffic, building materials and construction, and network overhead lower actual data throughput rate.

Restoring the Default Password and Configuration Settings

You can restore the factory default configuration settings that reset the router's user name to **admin**, the password to **password**, and the IP address to **192.168.1.1**.



This procedure will erase all the current configuration settings and restore the factory defaults.

To restore the factory default configuration settings:

1. Use a sharp object such as a pen or a paper clip to press and hold the restore factory settings button, located on the rear panel of the router, for about 5 seconds, until the Power light begins to blink (see [“Back Panel” on page 5](#)).
2. Release the restore factory settings button, and wait for the router to restart, and for the Power light to stop blinking and become solid green.

The factory default settings will be restored so that you can access the router from your Web browser using the factory defaults.

Related Documents

This section provides links to reference documents that you can use to gain a more complete understanding of the technologies used in your NETGEAR product.

Table 3. Related Documents

Document	Link
Internet Networking and TCP/IP Addressing	http://documentation.netgear.com/reference/enu/tcpip/index.htm
Preparing a Computer for Network Access	http://documentation.netgear.com/reference/enu/wsdhcp/index.htm
Glossary	http://documentation.netgear.com/reference/enu/glossary/index.htm

Registration and Certifications

Product Registration, Support, and Documentation

Register your product at <http://www.NETGEAR.com/register>. You must register before you can use our telephone support service. Product updates and Web support are always available by going to: <http://www.NETGEAR.com/support>.

Setup documentation is available on the CD, on the support website, and on the documentation website. When the wireless router is connected to the Internet, click the KnowledgeBase link to view support information or click the Documentation link to view the online *User Manual* for this wireless router.

Maximum Wireless Signal Rate Derived from IEEE Standard 802.11 Specifications

Actual data throughput will vary. Network conditions and environmental factors, including volume of network traffic, building materials and construction, and network overhead, lower actual data throughput rate.

Federal Communications Commission (FCC) Compliance Notice: Radio Frequency Notice

This equipment has been tested and found to comply with the limits for a Class B digital device, pursuant to part 15 of the FCC Rules. These limits are designed to provide reasonable protection against harmful interference in a residential installation. This equipment generates, uses, and can radiate radio frequency energy and, if not installed and used in accordance with the instructions, may cause harmful interference to radio communications. However, there is no guarantee that interference will not occur in a particular installation. If this equipment does cause harmful interference to radio or television reception, which can be determined by turning the equipment off and on, the user is encouraged to try to correct the interference by one or more of the following measures:

- Reorient or relocate the receiving antenna.
- Increase the separation between the equipment and receiver.
- Connect the equipment into an outlet on a circuit different from that to which the receiver is connected.
- Consult the dealer or an experienced radio/TV technician for help.

